

Fiche Technique Série – G

KSF G 66x550-1xM8

Longueur nominale (mm)

550

Diamètre du tube (mm)

66

Poids (kg)

1,60

Code article

20055

Spécifications

- Système de spirale unique soudée en continu
- Galvanisation à chaud selon la norme DIN ISO 1461
- Corps conique breveté forgé d'une seule pièce

Applications



Accessoires



Granulés spéciaux
 0,50 kg
 Code : 21823

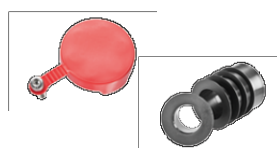

Kit douilles de réduction
 0,10 kg
 Code : 21806



Fixation articulée-G66
 0,30 kg
 Code : 21804



Insert-G66
 0,10 kg
 Code : 21839



Barre de vissage courte
 0,60 kg
 Code : 20070



Fixation invisible-G66
 0,20 kg
 Code : 21805



Obtuteur-G66
 0,10 kg
 Code : 21856

Sous réserve de modification

Krinner SAS | 18, rue du Baron Chouard | 67700 Monswiller (France)

Tél : +33 388 714 856 | Fax : +33 388 714 547 | contact@krinner.fr | www.krinner.fr

efficace – sans béton - durable

Fiche Technique Série – G

KSF G 66x550-1xM8

	Longueur (mm) (± 25 mm)
a	550
	Diamètre extérieur de la tige (mm)
b	66
	Diamètre intérieur (mm)
c	62
	Diamètre d'ajustement (mm)
d	62 55,5 50 43 38,5 34
	Profondeur d'ajustement (mm) (± 25 mm)
e	110 128 145 176 217 295
	Filetage
f	1 x M8

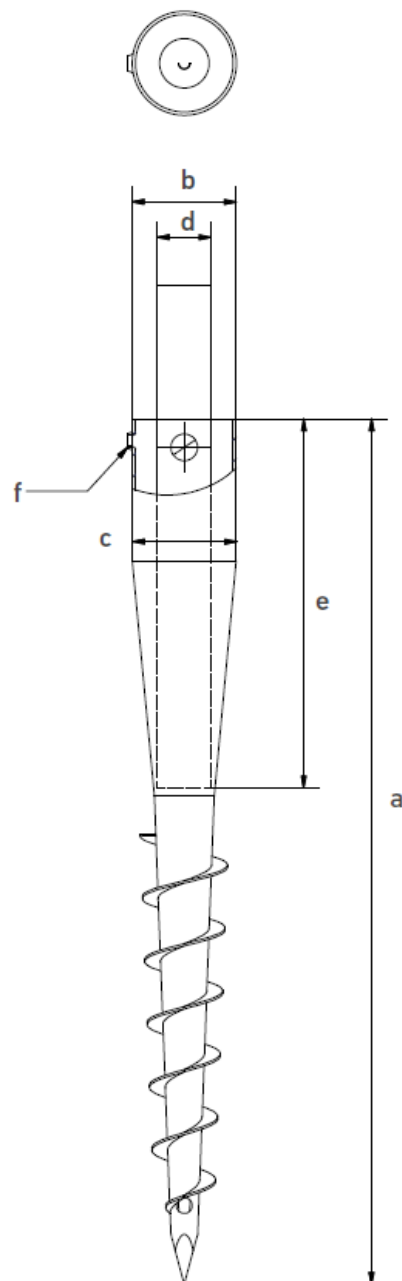

Service Online
G2005511D

